

M860D TOWER CRANE

TYPICAL LOADS	
LOAD	RADIUS
96T	10.0m
64T	15.0m
32T	30.0m
7T	70.0m

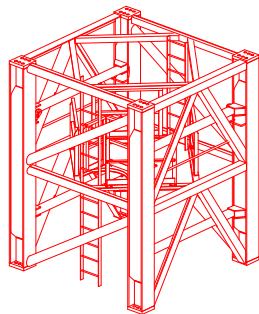

Technical Data Sheet

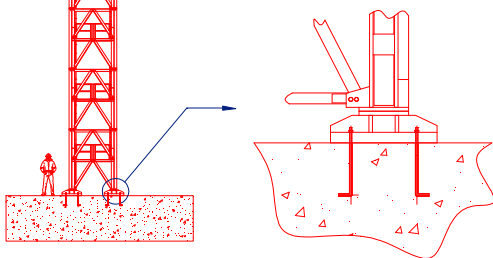

FAVELLE
FAVCO

M860D RADIUS AND CAPACITY (WITHOUT AUXILIARY HOIST)



Boom Length	Max Rad. for Max WLL	Min Rad.	WLL at Min Rad.	1 FALL																				Max Rad.	WLL at Max Rad.
				Radius(metres) & Capacity (tonnes)																					
(m)	(m)	(m)	(T)	10.0	15.0	20.0	25.0	30.0	35.0	37.5	40.0	42.5	45.0	47.5	50.0	52.5	55.0	57.5	60.0	62.5	65.0	67.5	70.0	(m)	(T)
73.4	7.5	6.6	32.0	31.6	28.6	25.2	23.3	21.6	19.9	19.1	18.4	17.6	16.9	15.9	14.8	13.6	12.6	11.6	10.8	10.0	9.2	8.4	7.1	71.8	6.0
68.8	20.0	6.3	32.0	32.0	32.0	32.0	30.1	28.1	25.0	22.7	20.7	19.0	17.5	16.1	14.9	13.7	12.8	11.7	10.8	10.0	9.0			67.4	7.8
64.2	27.5	5.9	32.0	32.0	32.0	32.0	32.0	30.8	25.7	23.4	21.4	19.6	18.1	16.8	15.5	14.4	13.4	12.4	11.4	10.2				62.9	9.8
59.6	27.5	5.7	32.0	32.0	32.0	32.0	32.0	30.8	26.0	23.7	21.7	20.0	18.4	17.0	15.8	14.6	13.3	11.3						58.5	10.5
55.0	27.5	5.7	32.0	32.0	32.0	32.0	32.0	31.6	26.5	24.2	22.2	20.5	18.9	17.5	16.0	13.1								54.0	12.8
50.4	27.5	5.0	32.0	32.0	32.0	32.0	32.0	31.7	26.7	24.4	22.4	20.7	19.1	17.6										49.6	16.3
45.8	30.0	4.7	32.0	32.0	32.0	32.0	32.0	32.0	27.1	24.9	22.9	21.1	19.6											45.2	19.4
41.2	30.0	4.3	32.0	32.0	32.0	32.0	32.0	32.0	27.4	25.1	22.7													40.7	22.1
36.6	30.0	4.0	32.0	32.0	32.0	32.0	32.0	32.0	27.7															36.3	26.4

Boom Length	Max Rad. for Max WLL	Min Rad.	WLL at Min Rad.	2 FALL																				Max Rad.	WLL at Max Rad.
				Radius(metres) & Capacity (tonnes)																					
(m)	(m)	(m)	(T)	10.0	15.0	20.0	25.0	30.0	35.0	37.5	40.0	42.5	45.0	47.5	50.0	52.5	55.0	57.5	60.0	62.5	65.0	67.5	70.0	(m)	(T)
73.4	-	6.4	36.2	36.2	35.7	32.4	29.6	27.2	24.7	22.1	19.9	17.9	16.1	14.6	13.2	11.9	10.8	9.8	8.8	8.0	7.2	6.5	5.9	71.2	5.7
68.8	-	6.0	46.0	41.9	35.5	31.4	30.1	28.1	25.2	23.3	21.4	19.7	18.1	16.6	15.2	13.9	12.8	11.8	10.8	10.0	9.0			66.8	7.0
64.2	-	5.7	54.0	47.5	40.7	37.5	34.6	31.9	26.8	24.5	22.3	20.6	18.8	17.4	16.0	14.8	13.6	12.6	11.4					62.4	9.7
59.6	5.4	5.4	64.0	52.4	46.1	42.5	37.6	32.1	27.3	24.9	22.9	20.9	19.4	17.9	16.4	15.0	13.3	11.3						57.9	10.0
55.0	6.3	5.1	64.0	57.3	51.4	47.8	40.1	32.8	26.8	25.0	22.9	21.5	19.8	18.2	16.4	14.0								53.5	12.6
50.4	9.0	4.7	64.0	62.6	56.7	52.3	42.2	34.0	28.0	25.7	23.6	21.8	20.2	18.0										49.0	16.0
45.8	11.8	4.4	64.0	64.0	62.8	55.3	42.9	34.5	28.6	26.2	24.0	21.2												44.6	18.0
41.2	16.6	4.1	64.0	64.0	64.0	55.8	43.1	34.8	28.7	26.1	23.1													40.1	22.9
36.6	16.8	3.8	64.0	64.0	64.0	56.1	43.6	35.3	26.8															35.7	25.6

Boom Length	Max Rad. for Max WLL	Min Rad.	WLL at Min Rad.	3 FALL																				Max Rad.	WLL at Max Rad.
				Radius(metres) & Capacity (tonnes)																					
(m)	(m)	(m)	(T)	10.0	15.0	20.0	25.0	30.0	35.0	37.5	40.0	42.5	45.0	47.5	50.0	52.5	55.0	57.5	60.0	62.5	65.0	67.5	70.0	(m)	(T)
73.4	-	6.1	37.0	37.0	36.4	32.9	29.8	27.2	24.8	22.1	19.7	17.7	15.8	14.2	12.8	11.5	10.3	9.3	8.3	7.5	6.7	6.0	5.5	71.3	5.2
68.8	-	5.8	48.0	43.4	36.6	32.6	31.6	29.0	24.4	22.4	20.6	19.1	17.5	16.0	14.7	13.5	12.4	11.4	10.5	9.7	8.7			66.9	6.5
64.2	-	5.5	60.0	50.2	42.3	38.6	36.9	30.9	25.9	23.8	21.9	20.0	18.3	16.8	15.4	14.2	13.2	12.2	11.0	9.2				62.5	9.2
59.6	-	5.2	69.0	57.5	48.3	44.2	36.6	30.0	27.0	24.6	22.4	20.6	18.8	17.4	15.9	14.4	12.6	10.8						58.0	9.4
55.0	-	4.8	80.0	64.9	55.0	48.7	38.6	31.6	26.3	24.0	22.0	21.2	19.6	17.8	15.8	13.6								53.6	12.1
50.4	-	4.5	85.0	71.8	63.2	54.3	43.0	34.5	28.2	25.8	23.5	21.6	20.0	17.6										49.1	16.1
45.8	4.2	4.2	96.0	79.6	70.3	53.4	43.9	35.2	29.0	26.3	23.5	20.5	17.5											44.7	17.5
41.2	6.7	3.9	96.0	88.7	77.6	57.2	44.2	35.6	29.3	26.2	23.5													40.2	23.2
36.6	11.8	3.6	96.0	96.0	78.2	57.8	44.7	35.9	25.8															35.8	25.5

M860D RADIUS AND CAPACITY (WITH AUXILIARY HOIST)



Boom Length	Max Rad. for Max WLL	Min Rad.	WLL at Min Rad.	1 FALL																	Max Rad.	WLL at Max Rad.			
				Radius(metres) & Capacity (tonnes)																					
(m)	(m)	(m)	(T)	10.0	15.0	20.0	25.0	30.0	35.0	37.5	40.0	42.5	45.0	47.5	50.0	52.5	55.0	57.5	60.0	62.5	65.0	67.5	70.0	(m)	(T)
73.4	8.5	6.1	32.0	36.2	35.7	32.4	29.6	27.2	24.7	22.1	19.9	17.9	16.1	14.6	13.2	11.9	10.8	9.8	8.8	8.0	7.2	6.5	5.9	71.3	5.0
68.8	11.5	5.8	32.0	41.9	35.5	31.4	30.1	28.1	25.2	23.3	21.4	19.7	18.1	16.6	15.2	13.9	12.8	11.8	10.8	10.0	9.0			66.9	6.9
64.2	16.4	5.5	32.0	47.5	40.7	37.5	34.6	31.9	26.8	24.5	22.3	20.6	18.8	17.4	16.0	14.8	13.6	12.6	11.4	9.7				62.5	7.9
59.6	24.0	5.2	32.0	52.4	46.1	42.5	37.6	32.1	27.3	24.9	22.9	20.9	19.4	17.9	16.4	15.0	13.3	11.3						58.0	9.4
55.0	28.2	4.8	32.0	57.3	51.4	47.8	40.1	32.8	26.8	25.0	22.9	21.5	19.8	18.2	16.4	14.0								53.6	11.8
50.4	28.9	4.5	32.0	62.6	56.7	52.3	42.2	34.0	28.0	25.7	23.6	21.8	20.2	18.0										49.1	15.4
45.8	29.5	4.2	32.0	64.0	62.8	55.3	42.9	34.5	28.6	26.2	24.0	21.2	18.0											44.7	16.3
41.2	30.0	3.9	32.0	64.0	64.0	55.8	43.1	34.8	28.7	26.1	23.1													40.2	21.5
36.6	30.0	3.6	32.0	32.0	32.0	32.0	32.0	32.0	27.7															35.8	23.3

Boom Length	Max Rad. for Max WLL	Min Rad.	WLL at Min Rad.	2 FALL																	Max Rad.	WLL at Max Rad.			
				Radius(metres) & Capacity (tonnes)																					
(m)	(m)	(m)	(T)	10.0	15.0	20.0	25.0	30.0	35.0	37.5	40.0	42.5	45.0	47.5	50.0	52.5	55.0	57.5	60.0	62.5	65.0	67.5	70.0	(m)	(T)
73.4	-	6.4	36.2	36.0	33.3	29.5	26.9	24.8	22.0	20.1	18.5	16.9	15.3	13.9	12.6	11.1	10.2	9.1	8.1	7.2	6.3	5.4	4.6	71.2	4.2
68.8	-	6.0	46.0	41.2	34.8	30.7	29.4	27.8	24.1	22.0	20.2	18.5	17.4	16.0	14.6	13.2	12.1	11.1	10.2	9.0	7.7			66.8	7.0
64.2	-	5.7	54.0	47.5	40.0	35.9	34.6	30.6	25.5	23.4	21.4	19.6	18.0	16.4	15.0	13.7	12.8	11.7	10.2	8.2				62.4	8.2
59.6	-	5.4	62.0	52.4	45.5	42.0	36.6	29.7	26.7	24.4	22.2	20.4	18.6	16.8	15.2	13.5	11.8	9.8						57.9	9.6
55.0	5.1	5.1	64.0	57.3	51.4	47.3	38.6	31.3	25.8	23.4	21.5	20.8	18.9	17.0	14.9	12.6								53.5	12.2
50.4	5.7	4.7	64.0	62.6	56.7	52.3	42.2	33.7	27.6	25.2	23.0	21.2	19.4	16.8										49.0	16.0
45.8	10.0	4.4	64.0	64.0	62.8	54.0	42.7	34.2	28.2	25.6	22.8	19.6	16.6											44.6	16.6
41.2	15.0	4.1	64.0	64.0	64.0	55.8	43.0	34.4	28.4	25.4	23.1													40.1	22.9
36.6	15.0	3.8	64.0	64.0	64.0	56.1	43.5	35.0	25.4															35.7	24.9

Boom Length	Max Rad. for Max WLL	Min Rad.	WLL at Min Rad.	3 FALL																	Max Rad.	WLL at Max Rad.			
				Radius(metres) & Capacity (tonnes)																					
(m)	(m)	(m)	(T)	10.0	15.0	20.0	25.0	30.0	35.0	37.5	40.0	42.5	45.0	47.5	50.0	52.5	55.0	57.5	60.0	62.5	65.0	67.5	70.0	(m)	(T)
73.4	-	6.4	36.0	36.0	35.7	32.1	28.8	25.9	23.2	20.7	18.3	16.2	14.9	13.5	12.1	10.7	9.5	8.5	7.4	6.4	5.2	4.5	4.0	71.2	5.0
68.8	-	6.0	48.0	42.6	35.9	31.8	30.6	27.7	23.0	21.0	19.2	17.6	16.6	15.3	14.0	12.7	11.6	10.6	9.6	8.6	7.2			66.8	6.9
64.2	-	5.7	60.0	49.4	41.5	37.7	35.8	29.4	24.4	22.4	20.4	18.8	17.2	15.6	14.2	13.0	12.3	11.1	9.6	7.8				62.4	7.9
59.6	-	5.4	63.2	56.7	47.5	43.0	35.2	28.6	25.6	23.4	21.4	19.5	17.8	16.2	14.6	12.9	11.4	9.4						57.9	9.4
55.0	-	5.1	75.0	64.7	54.2	47.3	37.2	30.1	24.8	22.6	20.6	20.1	18.2	16.3	14.4	12.0								53.5	11.8
50.4	-	4.7	85.0	71.8	62.4	52.9	41.6	33.8	27.6	24.9	22.6	20.9	18.8	16.2										49.0	15.4
45.8	4.2	4.4	96.0	79.6	68.8	52.0	43.5	34.8	28.1	25.1	22.1	19.1	16.1											44.6	16.3
41.2	6.7	4.1	96.0	88.7	77.0	57.2	44.0	35.2	28.0	25.0	23.3													40.1	21.5
36.6	7.5	3.8	96.0	95.8	76.7	57.8	44.6	34.6	24.8															35.7	23.3

WITHOUT AUXILIARY HOIST

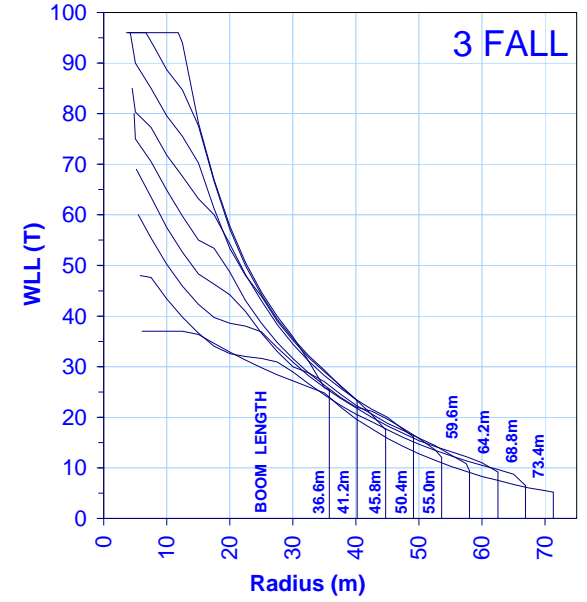
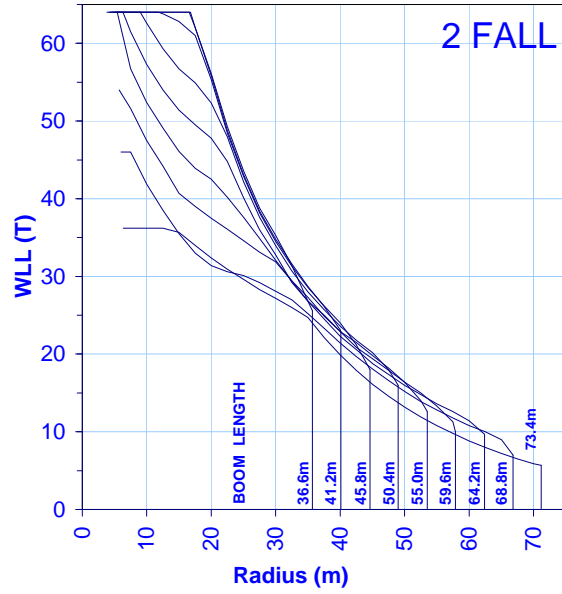
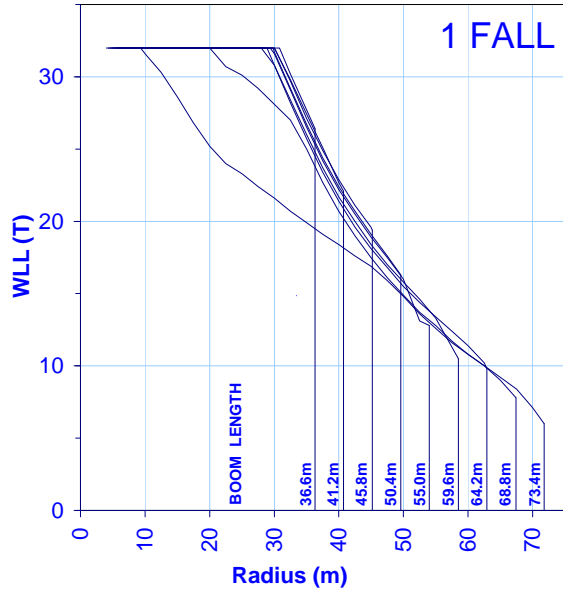

WITH AUXILIARY HOIST

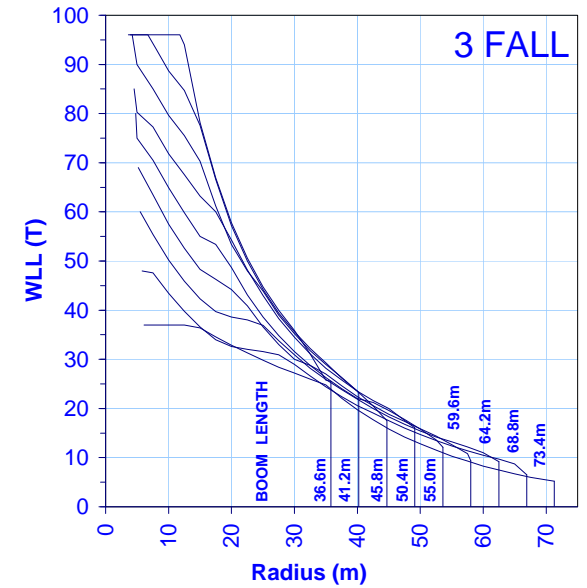
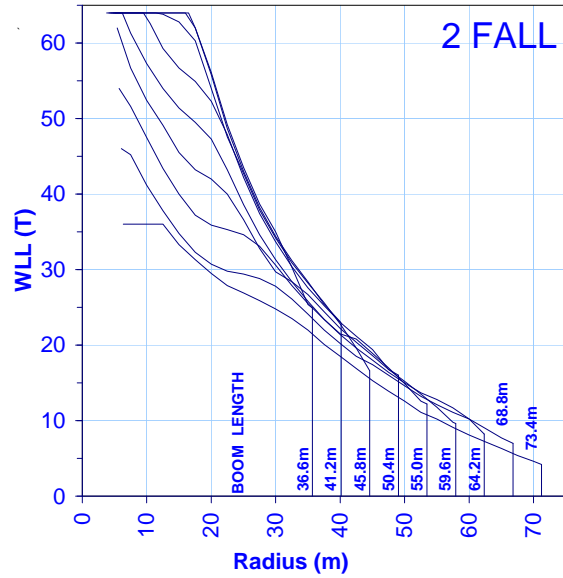
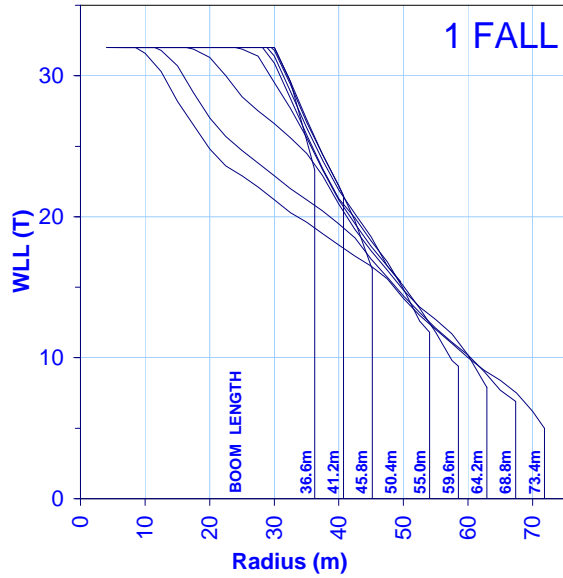

M860D RADIUS , CAPACITY & LOAD CHART (AUXILIARY HOIST)



Boom Length	Max Rad. for Max WLL	Min Rad.	1 FALL								WLL at Min Rad. (T)	Max Rad. (m)	WLL at Max Rad. (T)
			Radius(metres) & Capacity (tonnes)										
(m)	(m)	(m)	52.5	55.0	57.5	60.0	62.5	65.0	67.5	70.0	(T)	(m)	(T)
73.4	50.0	7.6	11.5	11.0	9.9	8.7	7.6	6.5	5.5	4.8	12.0	74.1	4.1
68.8	52.5	7.3	12.0	11.2	10.2	9.5	8.5	7.3	6.4	-	12.0	69.7	5.7
64.2	52.5	7.0	12.0	11.8	11.0	9.0	8.0	7.1	-	-	12.0	65.2	6.7
59.6	52.5	6.7	12.0	11.9	11.6	9.6	8.1	-	-	-	12.0	60.8	7.5
55.0	50.0	6.4	11.4	9.4	-	-	-	-	-	-	12.0	56.3	8.3
50.4	51.9	6.0	-	-	-	-	-	-	-	-	12.0	51.9	12.0
45.8	47.4	5.7	-	-	-	-	-	-	-	-	12.0	47.4	12.0
41.2	43.0	5.4	-	-	-	-	-	-	-	-	12.0	43.0	12.0
36.6	38.6	5.1	-	-	-	-	-	-	-	-	12.0	38.6	12.0

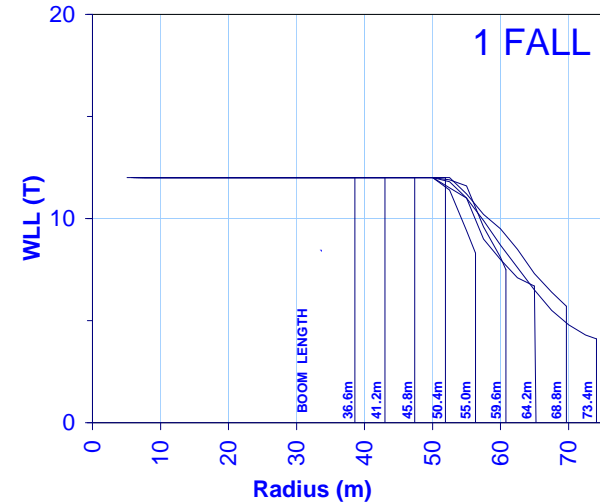

M860D SPEEDS

HOIST SPEED

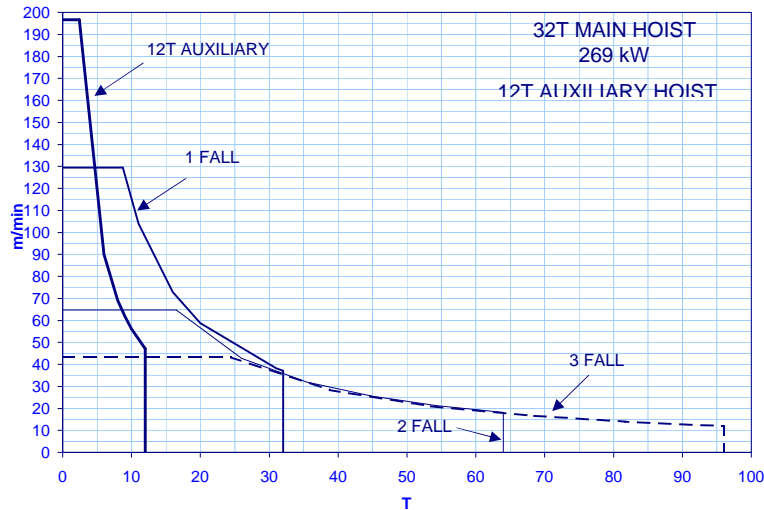

LOAD (T)	SPEED (m/min)
8.7	129.4
11.0	104.1
16.0	72.8
20.0	58.7
31.0	38.3
32.0	37.1
16.5	64.7
26.0	42.8
35.4	32.0
44.9	25.5
54.3	21.3
64.0	18.1
24.5	43.1
38.8	28.4
53.1	21.1
67.4	16.8
81.7	14.0
96.0	12.0
2.4	196.6
6.0	90.1
8.0	69.1
9.0	61.9
10.0	56.1
12.0	47.2

LUFF&SLEW SPEEDS

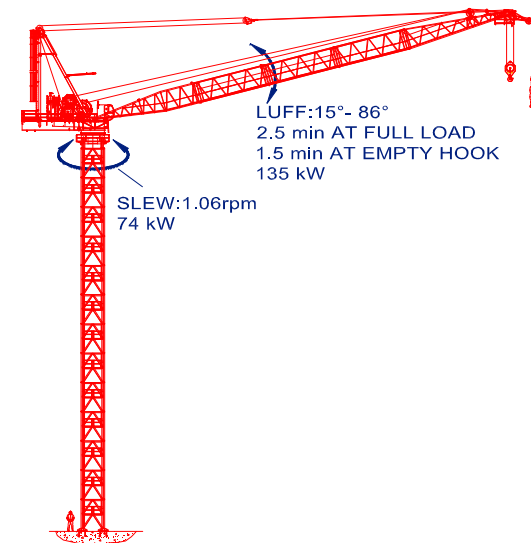

M860D GENERAL DIMENSIONS (TYPICAL CASES AT 55.0m BOOM LENGTH)



CRANE FREE-STANDING WITHOUT CLIMBING FRAME

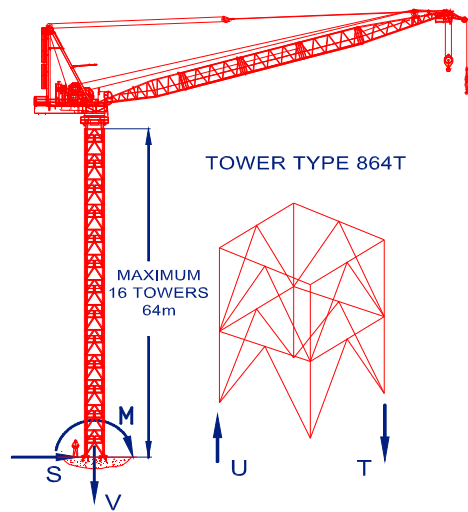

BUILDING REACTION

Design Load	I/S*	O/S†	O/S high ^	Unit
NO. of Towers	16	16	12	-
M	1394	1630	3094	mT
V	361	237	212	T
S	9	39	80	T
T	430	480	863	T
U	300	368	757	T
Ht _{Total}	64	64	48	m

INTERNAL CLIMBER ON COLLARS

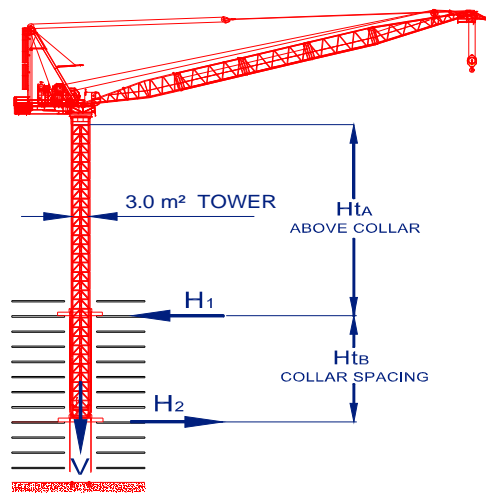

BUILDING REACTION

Design Load	I/S*	O/S†	O/S high^	Unit
NO. of Towers	16	16	12	-
V	261	237	212	T
H ₁	84	95	183	T
H ₂	76	62	117	T
Ht _A	48	48	32	m
Ht _B	16	16	16	m

WITH CLIMBER- ONE TIE ABOVE THE BASE

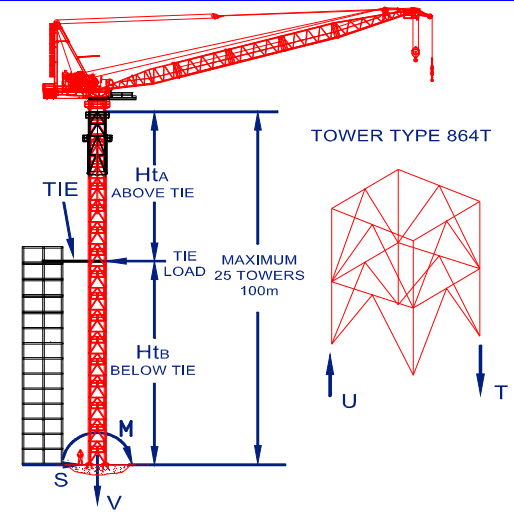

BUILDING REACTION

Design Load	I/S*	O/S†	O/S high^	Unit
NO. of Towers	25	25	18	-
TIE	48	77	199	T
M	660	643	1335	mT
V	336	311	268	T
S	40	39	118	T
T	257	296	417	T
U	89	91	283	T
Ht _A	50	50	38	m
Ht _B	50	50	34	m
Ht _{Total}	100	100	72	m

*:IN SERVICE WIND=20 m/s

†:OUT OF SERVICE WIND= 42 m/s

^:HIGH WIND (i.e. CYCLONE)= 65 m/s

Notes:

- Structure is designed using permissible stress method. These loads will vary by change of boom length, height and type of tower, actual site wind conditions, no of falls and change of wind speed.
- To calculate alternative options for M860D refer to Favelle Favco Design Sheet named "Crane Weight Wind Chart".

MACHINERY DECK ASSEMBLY

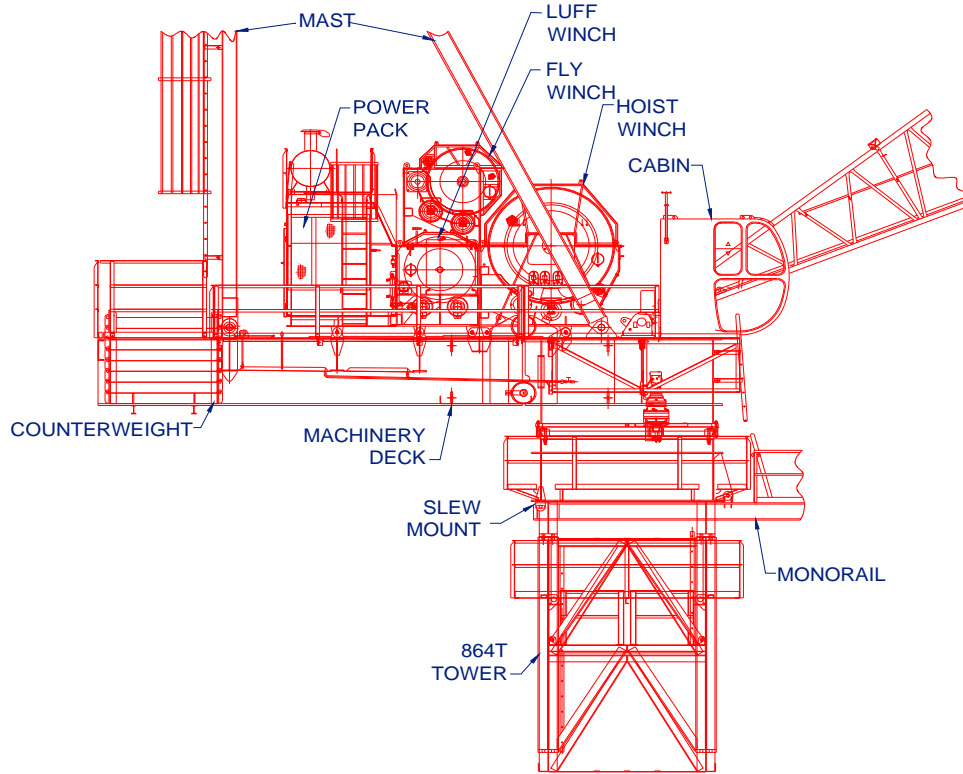



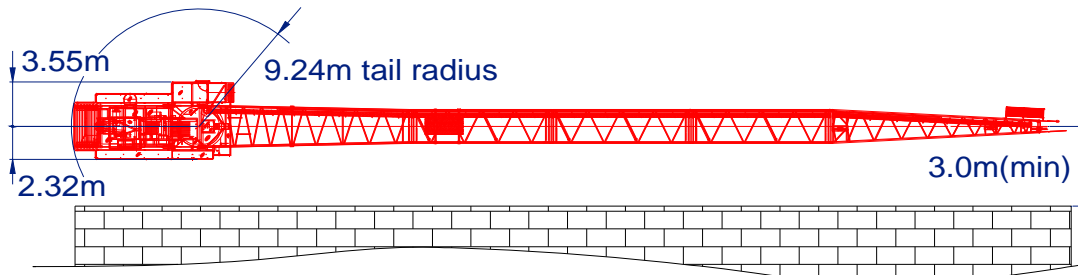







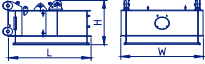
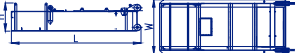
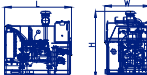
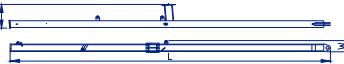

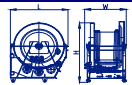
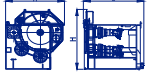
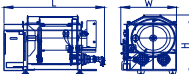

EXTERNAL CLIMBING INSTALLATION CLEARANCE

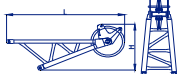

OUT OF SERVICE CONFIGURATION

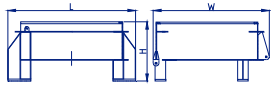
Boom Length (m)	Minimum weathervaning*	
	Radius (m)	Angle (°)
73.4	19.7	74.7
68.8	17.8	75.3
64.2	16.2	75.6
59.6	14.7	75.9
55.0	14.5	75.0
50.4	15.5	72.3
45.8	16.8	68.8
41.2	18.2	64.2
36.6	19.9	57.5

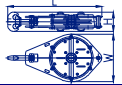
*: MINIMUM WEATHERVANING POSITION IS BASED ON THE WIND SPEED OF 20 m/s OR BOOM FLOAT AT 25 m/s

ITEM	QTY	DESCRIPTION	LENGTH L (mm)	HEIGHT H (mm)	WIDTH W (mm)	WEIGHT PER ITEM (kg)	
1	1	SPLIT DECK-FRONT (INCL. SLEW DRIVE, PINS & HANDRAILS)		3370	2127	3390	9675
2	1	SPLIT DECK-REAR		7255	1445	3390	12206
3	1	POWERPACK (INCL. 850L OF OIL)		3008	3207	2024	5020
4	2	MAST FRONT LEG		13250	1099	519	2545EA
	1	MAST HEAD		1120	1152	852	934
	2	MAST BACK LEG		12020	250	390	990EA
	1	BUFFER		3740	231	2974	398
		MAST ASSEMBLY (INC. SHEAVES, HEAD PIN, LADDERS, BUFFER AND PLATFORMS)					9716
5	1	CABIN & PLATFORM ASSEMBLY		4607	3286	1660	2470
6	1	MAIN HOIST WINCH ASSY (EMPTY DRUM) (750 m WINCH CAPACITY)		2464	2915	1765	9351
7	1	AUX. HOIST WINCH ASSY (EMPTY DRUM) (500 m WINCH CAPACITY)		1771	1937	1730	3708
8	1	LUFF WINCH ASSY (EMPTY DRUM)		2846	1995	1576	3968
9	1	BOOM BOTTOM 13.7m (INC. WALKWAY&PINS)		13963	3569	2815	2733
10	1	BOOM TOP 13.7m (INC. DEFLECTOR, SHEAVES & PINS) (PENDANT & PLATFORM)		14561	2814	1920	4281
11	5	BOOM EXTENSION 9.2m AND PENDANT BARS (BRIDLE PLATFORM 325 kg)		9316	2991	2814	2111 (2436)
12	1	BOOM FLY 2.4m		2845	1205	851	451
14	1	BRIDLE		1865	1010	1056	703
15	1	SLEW MOUNT (INCL. PLATFORMS 850Kg)		3710	1871	3370	6183
	1	SLEW RING (INCL. BOLTS)		3100 DIA.	175		2245
		Total					8428
16	1	CLIMBER		11530	1000	3500	16760
17	1	MONORAIL		8000	1697	650	3120
18	8	COUNTER WEIGHT		2750	257	1915	8194
19	1	HOOK - 3/2/1 FALL (96/64/32T)		2760	420	1340	2683
20	1	HOOK - 1 FALL (12T)		2804	320	327	520
20		TOWER SECTION (INC.LADDER,HAND RAIL,PLATFORM)		3050	4003	3031	6235
21	1	HOIST ROPE (42mm) @ 8.56kg/m		400m			3561
	1	HOIST ROPE (32mm) @ 5.01kg/m		200m			1042
22	1	LUFF ROPE (32mm) @ 4.87 kg/m		220m			1115