

Turmdrehkran

Tower Crane / Grue à tour / Gru a torre / Grúa torre
Guindaste de torre / Башенный поворотный кран

540 HC-L 12/24 Litronic®

▶ 540 HC-L 12/24

540 HC-L 16/32

540 HC-L 18/36

540 HC-L 16/32/48

540 HC-L 18/36/54

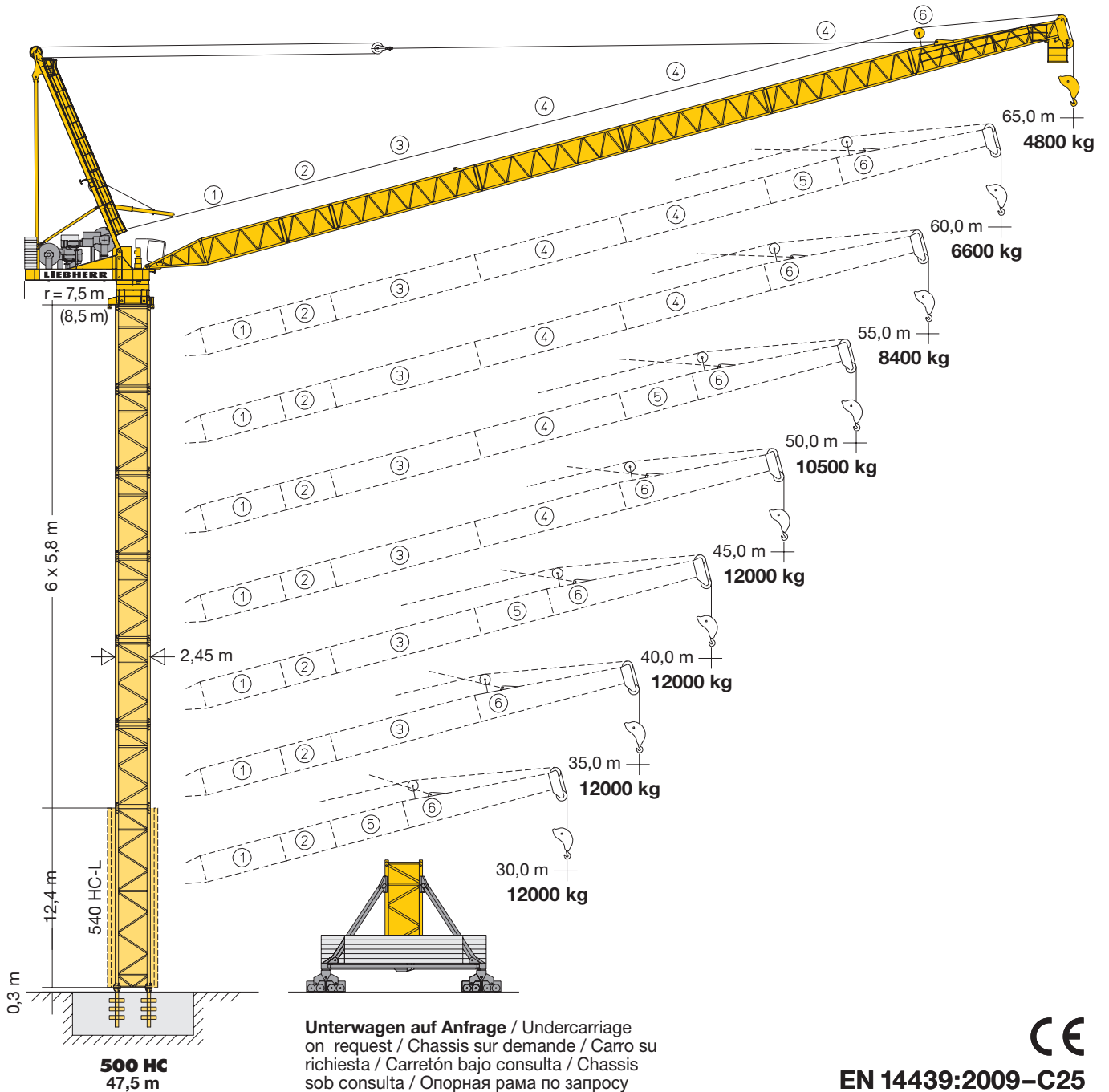

EN 14439:2009-C25

LIEBHERR

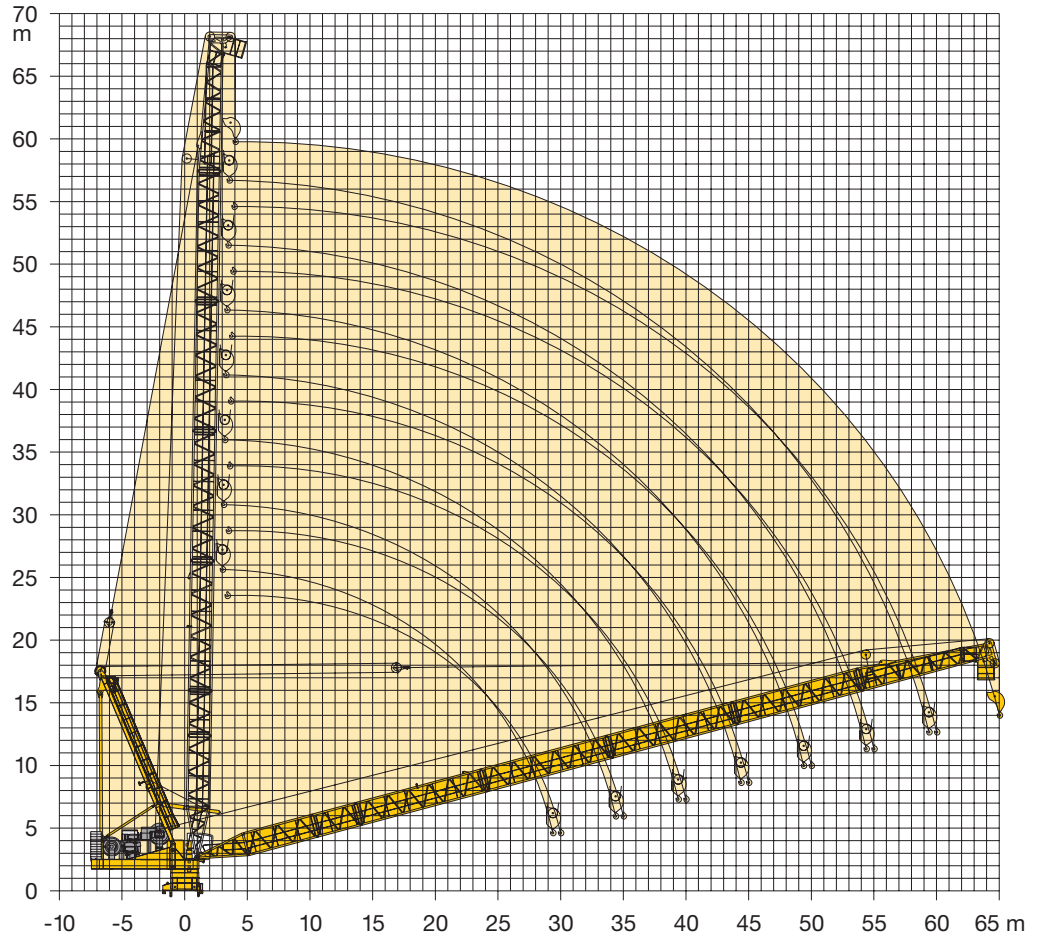

Turmhöhen

Tower heights / Hauteur de mât / Altezza torre / Alturas de torre / Alturas de torre / Высота башни

C 25	500 HC									
	Ausleger / Jib / Flèche / Braccio / Pluma / Lança / Стрела									
	30,0 m / 35,0 m 40,0 m / 45,0 m 50,0 m	55,0 m 60,0 m 65,0 m	30,0 m 35,0 m 40,0 m	45,0 m 50,0 m 55,0 m 60,0 m 65,0 m	30,0 m 35,0 m 40,0 m	45,0 m 50,0 m 55,0 m 60,0 m 65,0 m				
8	46,8*	–	59,1*	–	–	–	59,1*	–	–	–
7	41,0	41,0*	53,3	53,3*	–	–	53,3	53,3*	–	–
6	35,2	35,2	47,5	47,5	47,5*	–	47,5	47,5	47,5*	–
5	29,4	29,4	41,7	41,7	41,7	41,7*	41,7	41,7	41,7	41,7
4	23,6	23,6	35,9	35,9	35,9	35,9	35,9	35,9	35,9	35,9
3	17,8	17,8	30,1	30,1	30,1	30,1	30,1	30,1	30,1	30,1
2	12,0	12,0	24,3	24,3	24,3	24,3	24,3	24,3	24,3	24,3
1	6,2	6,2	18,5	18,5	18,5	18,5	18,5	18,5	18,5	18,5
0	0,4	0,4	12,7	12,7	12,7	12,7	12,7	12,7	12,7	12,7
	m		m				m			

* Außer Betrieb, Auslegerstellung 15° – 70°. / Out of operation, jib position 15° – 70°. / Hors service, position de flèche 15° – 70°. / Fuori servizio, posizione braccio 15° – 70°. / Posición de pluma, fuera de servicio 15° – 70°. / Posição da lança, fora de serviço 15° – 70°. / Вне работы, положение стрелы под углом 15° – 70°.



Ausladung und Tragfähigkeit

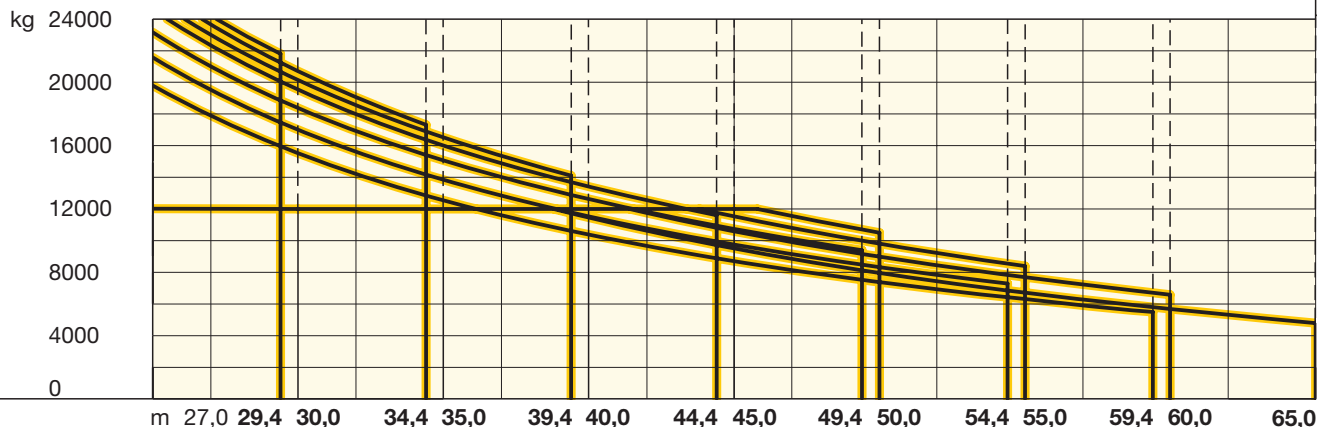

Radius and capacity / Portée et charge / Sbraccio e portata
Alcances y cargas / Alcance e capacidade de carga / Вылет и грузоподъемность

m	m/kg	m/kg															
		27,0	30,0	32,0	35,0	37,0	40,0	42,0	45,0	47,0	50,0	52,0	55,0	57,0	60,0	62,0	65,0
65,0	4,0-38,8 12000	12000	12000	12000	12000	12000	11450	10610	9500	8850	7960	7440	6710	6280	5680	5320	4800
60,0	4,0-41,4 12000	12000	12000	12000	12000	12000	12000	11750	10590	9910	8990	8450	7690	7240	6600		
	4,0-21,6 24000	17880	15510	14210	12540	11600	10370	9650	8700	8130	7380	6920	6300	5920	59,4 m 5500		
55,0	4,0-43,8 12000	12000	12000	12000	12000	12000	12000	12000	11520	10800	9810	9220	8400				
	4,0-23,0 24000	19510	17000	15610	13840	12830	11520	10760	9750	9140	8330	7850	54,4 m 7300				
50,0	4,0-45,8 12000	12000	12000	12000	12000	12000	12000	12000	12000	11550	10500						
	4,0-24,3 24000	21010	18370	16910	15060	14000	12620	11810	10740	10100	49,4 m 9400						
45,0	4,0-45,0 12000	12000	12000	12000	12000	12000	12000	12000	12000	12000	12000						
	4,0-25,5 24000	22330	19530	17980	16010	14880	13410	12540	44,4 m 11600								
40,0	4,0-40,0 12000	12000	12000	12000	12000	12000	12000	12000	12000								
	4,0-26,1 24000	23000	20140	18550	16520	15360	39,4 m 14100										
35,0	4,0-35,0 12000	12000	12000	12000	12000												
	4,0-26,7 24000	23660	20710	19050	34,4 m 17300												
30,0	4,0-30,0 12000	12000	12000														
	4,0-27,2 24000	24000	29,4 m 21800														

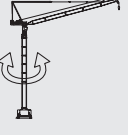



Tragfähigkeiten gültig bis 100 m Hubhöhe. Über 100 m Hubhöhe reduziert sich die Tragfähigkeit um das zusätzliche Seilgewicht. / Lifting capacities valid up to 100 m hoisting height. Over 100 m hoisting height, the lifting capacity is reduced by the additional rope weight. / Capacités de levage valables jusqu'à 100 m de hauteur sous crochet. Au-dessus de 100 m de hauteur sous crochet, la capacité de levage est réduite du poids de câble supplémentaire. / Portate valide fino a 100 d'altezze di sollevamento. Oltre i 100 m si riduce la portata causa il peso addizionale della fune. / Cargas válidas hasta altura de 100 m. Por encima de los 100 m se reduce la carga por el peso adicional del cable. / Cargas válidas até a altura de 100 m. Para além dos 100 m, reduz-se a carga pelo peso adicional do cabo. / Грузоподъемность действительна до 100 м высоты подъема. Свыше 100 м высоты подъема грузоподъемность сокращается на вес дополнительного каната.



	0 ↔ 0,6 sl./min tr./min	2 x 11 kW FU
	2,9 min 1,9 min	65 kW FU 110 kW FU
	Unterwagen auf Anfrage / Undercarriage on request / Chassis sur demande / Carro su richiesta / Carretón bajo consulta / Chassis sob consulta / Опорная рама по запросу	

	65 kW FU	110 kW FU	110 kW FU
	65 kW FU	65 kW FU	110 kW FU
kVA	143,0	185,0	228,0

kVA reduzierbar bei zu geringer Netz-Anschlussleistung, siehe BAL.
 kVA can be reduced in case of too little power of the mains, see instruction manual. / kVA peut être réduit en cas de trop faible puissance du réseau, voir manuel d'instruction. / kVA riducibili in caso di potenza di rete ridotta (si veda manuale uso e manutenzione) / kVA variable para potencia de red demasiado pequeña, ver Manual de instrucciones. / kVA reduzível no caso de capacidade da rede elétrica muito baixa, ver manual de instruções. / Количество кВА может быть сокращено до минимальной общей потребляемой мощности, см. инструкцию по эксплуатации.

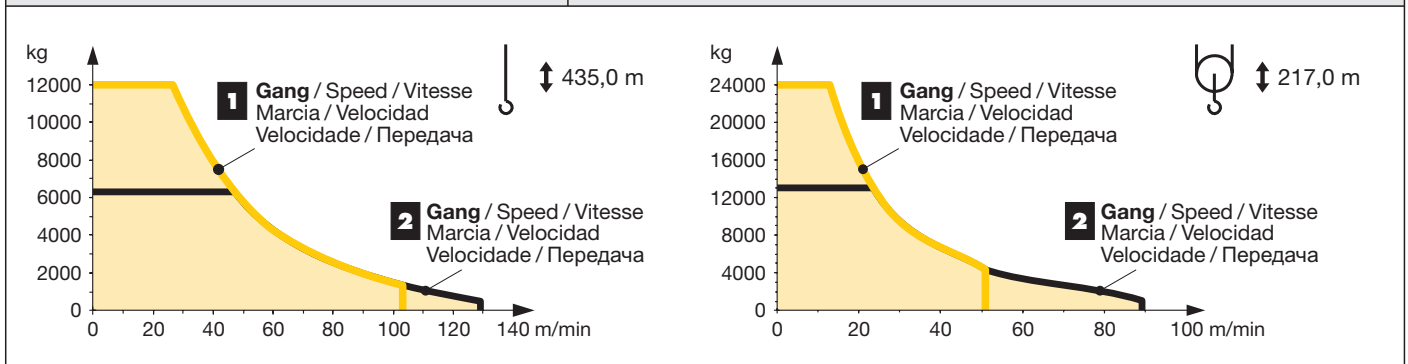
		↔ stufenlos / stepless / régl. continu / regl. progressiva / sin escalones sem degraus / бесступенчатый					
65 kW FU WIW 280 VZ 411	max. 1290 m	kg	m/min	kg	m/min		
	4 Lagen / Layers Couches / Avvolgimenti Camadas / Capas / Слоёв	1	12000	0 ↔ 27	1	24000	0 ↔ 13
			1300	0 ↔ 103		4300	0 ↔ 51
		2	6300	0 ↔ 47	2	13000	0 ↔ 23
			500	0 ↔ 129		1100	0 ↔ 89



		↔ stufenlos / stepless / régl. continu / regl. progressiva / sin escalones sem degraus / бесступенчатый					
110 kW FU WIW 300 VZ 412	max. 1290 m	kg	m/min	kg	m/min		
	4 Lagen / Layers Couches / Avvolgimenti Camadas / Capas / Слоёв	1	12000	0 ↔ 45	1	24000	0 ↔ 23
			5300	0 ↔ 83		11200	0 ↔ 42
		2	6300	0 ↔ 78	2	13200	0 ↔ 39
			2100	0 ↔ 144		5600	0 ↔ 72
		3	3000	0 ↔ 131	3	7100	0 ↔ 65
			300	0 ↔ 240		2300	0 ↔ 120

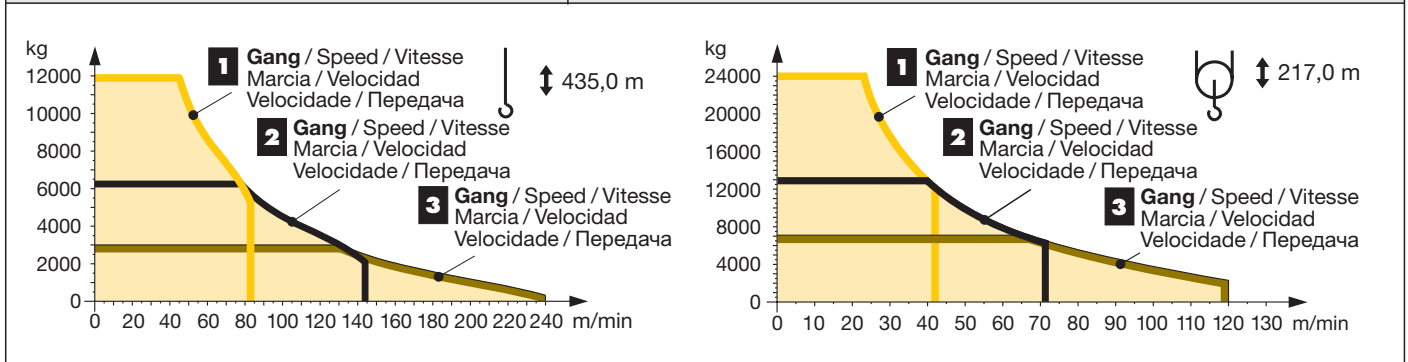

		500 HC								
n	Ausleger / Jib / Flèche / Braccio / Pluma / Lança / Стрела									
	30,0 / 35,0 / 40,0 / 45,0 / 50,0 m		55,0 / 60,0 / 65,0 m		30,0 / 35,0 / 40,0 / 45,0 / 50,0 m		55,0 / 60,0 m		65,0 m	
6	h	46,8	-	-	-	46,4	-	-	-	-
5		41,0	41,0	-	-	40,6	40,6	-	-	-
4		35,2	35,2	-	-	34,8	34,8	-	-	34,8
3		29,4	29,4	-	-	29,0	29,0	-	-	29,0
2		23,6	23,6	-	-	23,2	23,2	-	-	23,2
1		17,8	17,8	-	-	17,4	17,4	-	-	17,4
0		12,0	12,0	-	-	11,6	11,6	-	-	11,6

Außer Betrieb, Auslegerstellung 15° – 70°. / Out of operation, jib position 15° – 70°. / Hors service, position de flèche 15° – 70°.
 Fuori servizio, posizione braccio 15° – 70°. / Posición de pluma, fuera de servicio 15° – 70°. / Posição da lança, fora de serviço 15° – 70°.
 Вне работы, положение стрелы под углом 15° – 70°.

¹⁾ **Min. Verankerungshöhe kann bei max. Turmhöhe bzw. bei Hakenhöhe > 100m abweichen.** / Min. anchoring height may deviate at max. tower height resp. hook height > 100 m. / La hauteur d'ancrage min. peut différer en cas de hauteur de mât max. resp. en cas de hauteur sous crochet > 100m. / In caso dell'altezza max torre/gancio, l'altezza min. di ancoraggio può differire di > 100m. / La altura mínima de arriostamiento puede variar con una altura máxima de torre, es decir para alturas bajo gancho > 100m. / Em uma torre, com uma altura do gancho > 100 m a altura mín. do ancoramento pode variar. / Мин. высота крепления к зданию может изменяться при макс. высоте башни или при высоте крюка более 100м.

Kolli-Liste

Packing List / Liste de colisage / Lista dei colli
 Lista de contenido / Lista de embalagem / Упаковочный лист

Montagegewichte: siehe Betriebsanleitung. / Erection weights: see instruction manual. / Poids de montage: voir manuel de service. / Pesos di montaggio: vedere manuale d'uso. / Peso para el montaje: según manual. / Pesos de montagem: vejäm-se as instruções p. uso. / Масса монтируемых частей: см. инструкцию по эксплуатации.

Kranoberteil		Upper part of crane / Partie supérieure de grue / Parte superiore della gru Parte superior grúa / Parte superior do guindaste / Верхняя часть крана			L (m)	B (m)	H (m)	kg*
Pos. Item	Anz. Qty.	Drehkranz-Auflage / Slewing ring support Pivot / Ralla / Corona de giro / Cremalheira Рама поворотного круга			2,85	2,27	2,00	6250
Rep. Voce	Qte. Cta.							
1	1	Anschlußträger / Connection plate / Plaque de raccordement Piastra di collegamento Soporte de conexión / Suporte de conexão / Соединительная балка			3,30	0,60	1,10	1550
2	1		Drehbühne mit Rollendrehkranz / Slewing platform with slewing ring Plate-forme tournante avec roulement / Piattaforma girevole con ralla Plataforma de giro con asiento de pista / Plataforma giratoria com suporte de cremalheira / Поворотная платформа с роликовым поворотным кругом			3,00	2,25	2,53
3	1	Getriebebühne / Gear platform / Plate-forme des mécanismes Piattaforma meccanismi / Plataforma de mecanismos Plataforma de mecanismos / Лебедочная платформа				6,75	2,22	2,53
4	1		Hubwerk 110 kW / Hoist gear / Mécanisme de levage Argano di sollevamento / Mecanismo de elevación Mecanismo de elevação / Механизм подъема			3,90	2,28	2,00
5	1	Einzehwerk 110 kW / Luffing gear / Mécanisme de relevage Argano sollevamento braccio / Mecanismo de elevación pluma Mecanismo de elevação da lança / Стрелоподъемный механизм				3,10	2,32	1,60
6	1		Fahrerhauspodest mit Kabine / Driver's cabin with platform / Cabine de grutier avec plate-forme Pedana gruista con cabina / Plataforma con cabina Plataforma com cabina / Площадка с кабиной			6,00	2,20	2,57
7	3	Seitenpodest / Side platform / Plate-forme latérale Pedana lateral / Plataforma lateral / Plataforma lateral Боковая площадка				6,50	1,20	1,00

Pos. Item Rep. Voce Pos. Ref. Поз.	Anz. Qty. Qte. Qta. Cant. Cant. Кол-во				L (m)	B (m)	H (m)	kg*	
8	1	Auslegerhaltebock, geteilt / Jib retaining frame, split / Chevalet de retenue de flèche, en éléments / Cavalletto tirante braccio, diviso / Caballete de soporte de pluma, dividido / Cavalete de suporte da lança, dividido / Кронштейн стрелы, составной			12,01	2,28	2,56	10100	
9	1	Ausleger-Anlenkstück / Jib heel section / Pied de flèche / Sezione articolata braccio / Pluma tramo primero / Base articulada de lança / Корневая секция стрелы			10,00	1,96	1,90	3000	
10	1	Ausleger-Zwischenstück 3,6 m / Intermediate jib section / Élément intermédiaire de flèche / Sezione intermedia braccio / Tramo intermedio pluma / Peça suplementar da lança / Промежуточная секция стрелы			3,85	1,90	1,90	1050	
11	1	Ausleger-Zwischenstück 10,36 m (Festpunkt) / Intermediate jib section (fixed point) / Élément intermédiaire de flèche (point fixe) / Sezione intermedia braccio (punto fisso) / Tramo intermedio pluma (punto fijo) / Tramo intermédio da lança (ponto fixo) / Промежуточная секция стрелы (Фиксированная точка)			10,60	1,90	2,10	2600	
12	3	Ausleger-Zwischenstück 10,36 m / Intermediate jib section / Élément intermédiaire de flèche / Sezione intermedia braccio / Tramo intermedio pluma / Peça suplementar da lança / Промежуточная секция стрелы			10,60	1,90	1,90	2300	
13	1	Ausleger-Zwischenstück 5,18 m (Festpunkt) / Intermediate jib section (fixed point) / Élément intermédiaire de flèche (point fixe) / Sezione intermedia braccio (punto fisso) / Tramo intermedio pluma (punto fijo) / Tramo intermédio da lança (ponto fixo) / Промежуточная секция стрелы (Фиксированная точка)			5,50	1,90	2,10	1250	
14	1	Ausleger-Kopfstück / Jib head section / Pointe de flèche / Punta braccio / Tramo punta de pluma / Cabeça de lança / Концевая секция стрелы			11,50	2,00	2,55	3300	
15	1	Unterflasche / Bottom hook block / Moufle inférieure / Bozzello inferiore / Polipasto inferior / Gincho inferior / Крюковая обойма			2,40	1,20	0,85	1550	
16	1	Einziehseilflasche / Luffing rope pulley block / Tambour de relevage / Bozzello di sollevamento braccio / Polipasto cable de retracción / Gincho de cabo de retração / Замок стрелового каната			1,50	1,20	1,10	600	
17	1	Hilfskran mit Lagerungen / Auxiliary crane with supports / Grue auxiliaire avec logements / Gru auxiliaria con supporti / Grúa auxiliar con apoyos / Grúa auxiliar com apoios / Вспомогательный кран			4,40	0,90	0,60	700	
Turm		Tower / Mât / Torre Torre / Torre / Башня							
18	1	Grundturmstück / Base tower section / Mât de base / Elemento di torre base / Tramo base / Peça de base de torre / Секция основания			630 EC-H 500 HC-L 540 HC-L	12,42 12,42 12,42	2,65 2,68 2,68	2,65 2,68 2,68	14064 17170 14461
19	1	Turmstück / Tower section / Élément de mât / Elemento di torre / Tramo torre / Torre / Башенная секция			500 HC 500 HC-L	6,28 6,28	2,45 2,45	2,45 2,45	6480 8120
Klettern am Gebäude		Climbing on the building / Télescopage à l'extérieur du bâtiment / Telescopaggio esterno all'edificio / Trepado exterior a edificio / Telescopagem exterior ao edificio / Нарращивание высоты крана, пристыгнутого к зданию							
20	2	Führungsstück-Hälfte mit Podesten / Guide section with platforma / Cage télescopique avec plate-formes / Sezione guida con pedane / Tramo guía con plataforma / Tramo guía com plataforma / Половина направляющей секции с площадками			12,60	2,95	1,75	3950	
21	1	Hydraulikanlage und Klettereinrichtung / Hydraulic unit and climbing equipment / Système hydraulique et équipement de télescopage / Impianto idraulico e dispositivo di telescopaggio / Sistema hidráulico y equipo de trepado / Sistema hidráulico e telescopagem / Гидроагрегат и обойма наращивания			-	-	-	3100	
Klettern im Gebäude		Climbing in the building / Télescopage dans le bâtiment / Pure varianti di gru allungabili / Subida no edificio / Trepado dentro del edificio / Самоподъём крана в здании							
22	1	Kletterturmstück (D1) / Climbing tower section / Élément de hissage de mât / Elemento torre di telescopaggio / Tramo de torre trepador / Tramo de telescopagem / Секция самоподъема			6,30	2,45	2,45	9600	
23	1	Kletterturmstück (D2) / Climbing tower section / Élément de hissage de mât / Elemento torre di telescopaggio / Tramo de torre trepador / Tramo de telescopagem / Секция самоподъема			6,30	2,45	2,45	9400	
24	1	Hydraulikanlage und Klettertraverse / Hydraulic unit and climbing cross members / Système hydraulique avec traverses de télescopage / Impianto idraulico e traverse di allungamento / Equipo hidráulico y travesía de trepado / Equipamento hidráulico e travessa de telescopagem / Гидроагрегат и траверса наращивания			-	-	-	3150	
25	1	Einspannturmstück (B) / Anchoring tower section / Élément de mât d'encastrement / Elemento torre d'ancoraggio / Tramo de torre inferior de trepado / Tramo de telescopagem inferior / Упорная секция			6,30	2,45	2,45	9300	
26	6	Führungsrahmen (Hälfte) / Guide frame (half) / Cadre de hissage (moitié) / Telaio guida (metà) / Bastidor guía (mitad) / Bastidor de guía (metade) / Направляющая рама (половина)			3,05	0,95	0,65	1700	
Ballast		Ballast / Lest / Zavorra Lastre / Lastro / Балласт							
27	11	Stahlballast / Steel ballast / Lest en acier / Contrappeso di acciaio / Lastres metálicos / Lastro metálico / Металлический балласт			4,50	0,90	0,20	4910	
Kleinteile		Small parts / Accessoires / Accessori Accesorios / Acessórios / Мелкие детали							
28	1	Seile, Kleinteile / Ropes, small parts / Câbles, accessoires / Funi, accessori / Cables, accesorios / Cabos, acessórios / Канаты, мелкие детали	4500						

* Einzelgewichte. / Single weights. / Poids individuels. / Singoli pesi. / Pesos unitarios. / Pesos de peças componentes.

Konstruktionsänderungen vorbehalten! / Subject to alterations! / Sous réserves de modifications! / Riservato il diritto di modifiche strutturali! / Sujeto a modificaciones! / Salvo modificação da construçao! / Права на внесение конструкторских изменений сохраняются!

Sämtliche Angaben erfolgen ohne Gewähr. / This information is supplied without liability. / Ces renseignements sont sans garantie. / Tutte le indicazioni fornite senza garanzia. / Declinamos toda responsabilidad derivada de la información proporcionada. / Declinamos qualquer responsabilidade quanto à informação fornecida. / Все данные указаны без обязательств.